

FJL6820

High Voltage Color Display Horizontal Deflection Output

- High Collector-Base Breakdown Voltage : $V_{CB0} = 1500V$
- Low Saturation Voltage : $V_{CE(sat)} = 3V$ (Max.)
- For Color Monitor

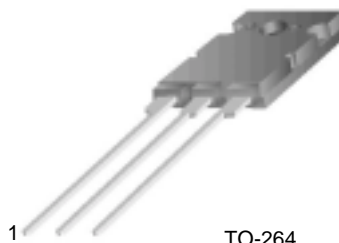

TO-264
1.Base 2.Collector 3.Emitter

NPN Triple Diffused Planar Silicon Transistor

Absolute Maximum Ratings $T_C=25^\circ C$ unless otherwise noted

Symbol	Parameter	Rating	Units
V_{CB0}	Collector-Base Voltage	1500	V
V_{CEO}	Collector-Emitter Voltage	750	V
V_{EBO}	Emitter-Base Voltage	6	V
I_C	Collector Current (DC)	20	A
I_{CP}^*	Collector Current (Pulse)	30	A
P_C	Collector Dissipation	200	W
T_J	Junction Temperature	150	$^\circ C$
T_{STG}	Storage Temperature	-55 ~ 150	$^\circ C$

* Pulse Test: $PW=300\mu s$, duty Cycle=2% Pulsed

Electrical Characteristics $T_C=25^\circ C$ unless otherwise noted

Symbol	Parameter	Test Conditions	Min.	Typ.	Max.	Units
I_{CES}	Collector Cut-off Current	$V_{CB}=1400V, R_{BE}=0$			1	mA
I_{CBO}	Collector Cut-off Current	$V_{CB}=800V, I_E=0$			10	μA
I_{EBO}	Emitter Cut-off Current	$V_{EB}=4V, I_C=0$			1	mA
V_{CB0}	Collector-Base Breakdown Voltage	$I_C=500\mu A, I_E=0$	1500			V
V_{CEO}	Collector-Emitter Breakdown Voltage	$I_C=5mA, I_B=0$	750			V
V_{EBO}	Emitter-Base Breakdown Voltage	$I_E=500\mu A, I_C=0$	6			V
h_{FE1}	DC Current Gain	$V_{CE}=5V, I_C=1A$	8			
h_{FE2}		$V_{CE}=5V, I_C=8.5A$	6		10	
h_{FE3}		$V_{CE}=5V, I_C=11A$	5.5		8.5	
$V_{CE(sat)}$	Collector-Emitter Saturation Voltage	$I_C=11A, I_B=2.75A$			3	V
$V_{BE(sat)}$	Base-Emitter Saturation Voltage	$I_C=11A, I_B=2.75A$			1.5	V
t_{STG}^*	Storage Time	$V_{CC}=200V, I_C=10A, R_L=20\Omega$			3	μs
t_F^*	Fall Time	$I_{B1}=2.0A, I_{B2}=-4.0A$		0.15	0.2	μs

* Pulse Test: $PW=20\mu s$, duty Cycle=1% Pulsed

Thermal Characteristics $T_C=25^\circ C$ unless otherwise noted

Symbol	Parameter	Typ	Max	Units
$R_{\theta JC}$	Thermal Resistance, Junction to Case		0.625	$^\circ C/W$

Typical Characteristics

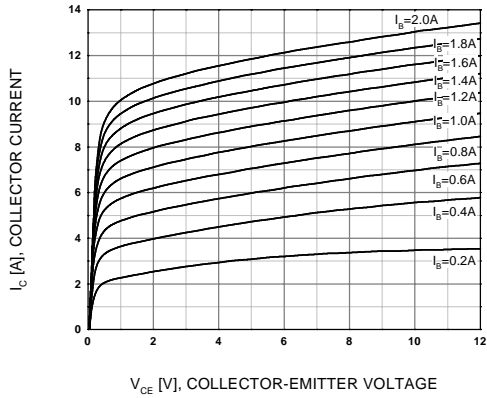

Figure 1. Static Characteristics

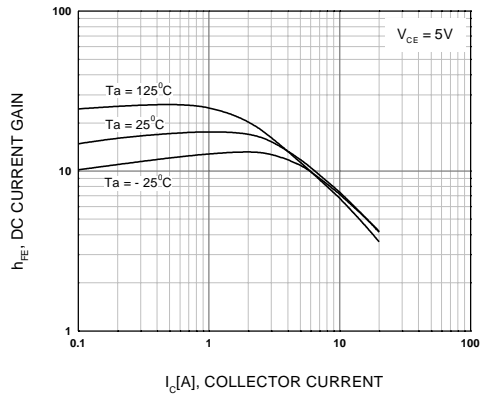

Figure 2. DC Current Gain

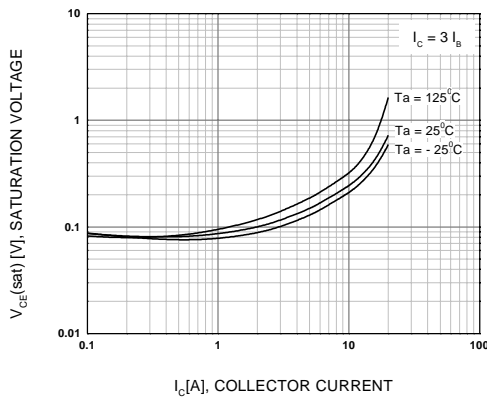

Figure 3. Collector-Emitter Saturation Voltage

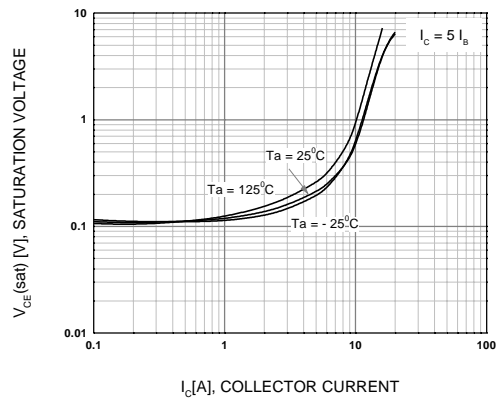

Figure 4. Collector-Emitter Saturation Voltage

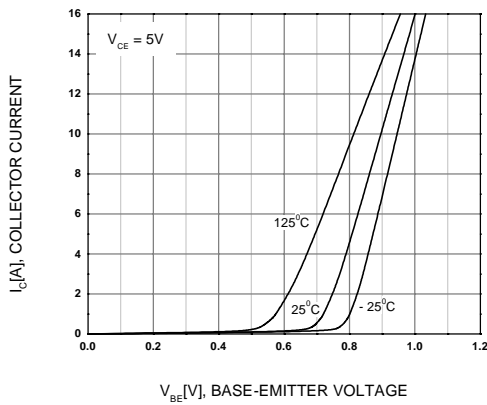

Figure 5. Base-Emitter On Voltage

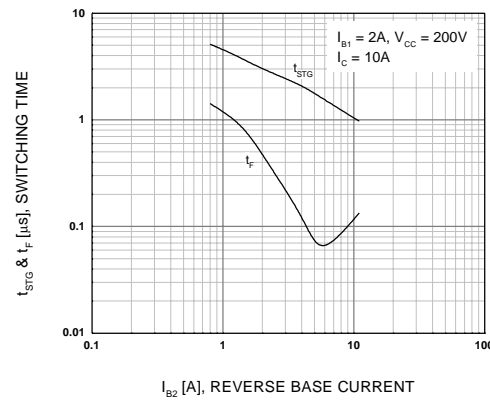

Figure 6. Resistive Load Switching Time

Typical Characteristics (Continued)

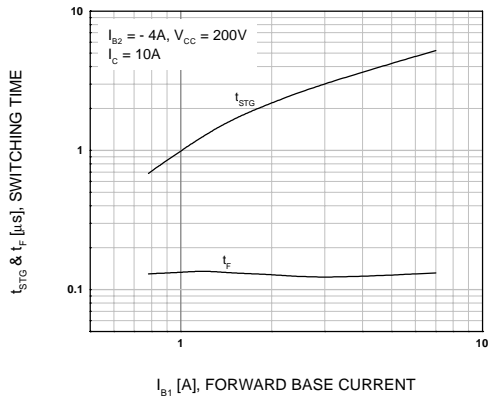

Figure 7. Resistive Load Switching Time

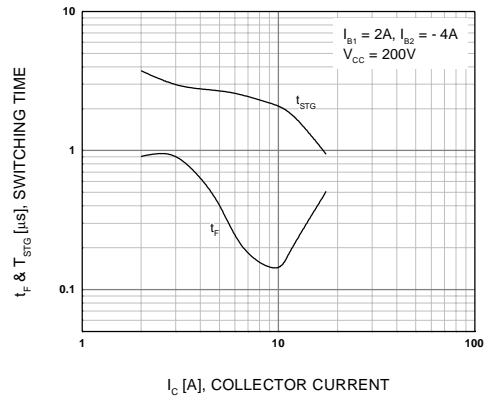

Figure 8. Resistive Load Switching Time

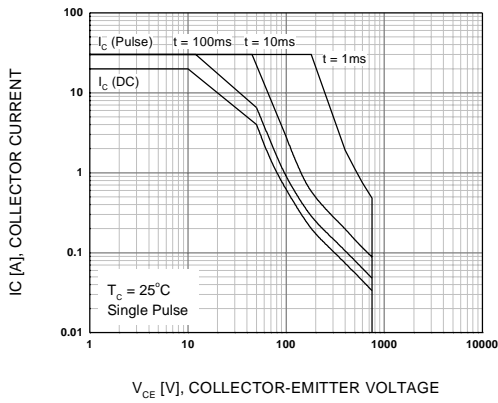

Figure 9. Forward Bias Safe Operating Area

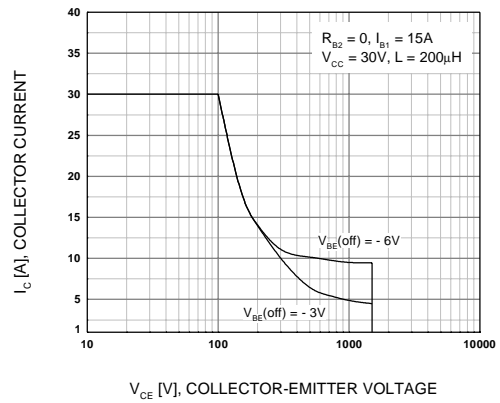

Figure 10. Reverse Bias Safe Operating Area

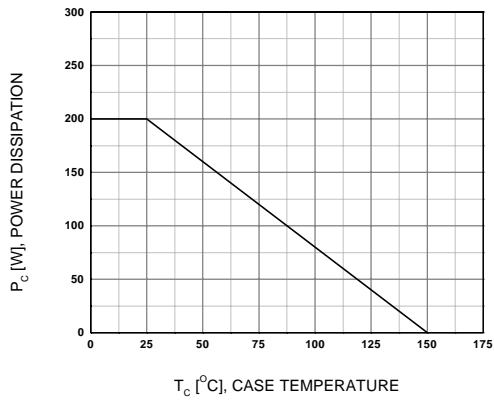
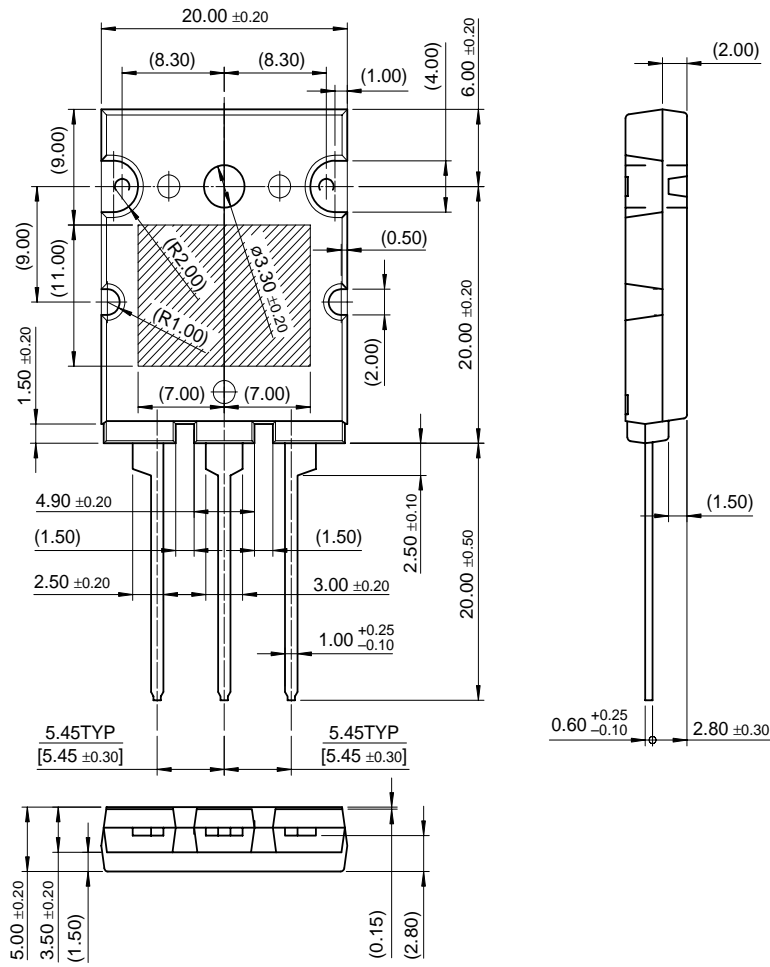

Figure 11. Power Derating

Package Dimensions

FJL6820

TO-264



Dimensions in Millimeters

TRADEMARKS

The following are registered and unregistered trademarks Fairchild Semiconductor owns or is authorized to use and is not intended to be an exhaustive list of all such trademarks.

ACE ^x TM	FAST [®]	OPTOPLANAR TM	SuperSOT TM -3
Bottomless TM	FAST ^r TM	PACMAN TM	SuperSOT TM -6
CoolFET TM	FRFET TM	POP TM	SuperSOT TM -8
CROSSVOLT TM	GlobalOptoisolator TM	PowerTrench [®]	SyncFET TM
DenseTrench TM	GTO TM	QFET TM	TinyLogic TM
DO ^{ME} TM	HiSeC TM	QS TM	UHC TM
EcoSPARK TM	ISOPLANAR TM	QT Optoelectronics TM	UltraFET [®]
E ² CMOS TM	LittleFET TM	Quiet Series TM	VCX TM
EnSigna TM	MicroFET TM	SLIENT SWITCHER [®]	
FACT TM	MICROWIRE TM	SMART START TM	
FACT Quiet Series TM	OPTOLOGIC TM	Stealth TM	

DISCLAIMER

FAIRCHILD SEMICONDUCTOR RESERVES THE RIGHT TO MAKE CHANGES WITHOUT FURTHER NOTICE TO ANY PRODUCTS HEREIN TO IMPROVE RELIABILITY, FUNCTION OR DESIGN. FAIRCHILD DOES NOT ASSUME ANY LIABILITY ARISING OUT OF THE APPLICATION OR USE OF ANY PRODUCT OR CIRCUIT DESCRIBED HEREIN; NEITHER DOES IT CONVEY ANY LICENSE UNDER ITS PATENT RIGHTS, NOR THE RIGHTS OF OTHERS.

LIFE SUPPORT POLICY

FAIRCHILD'S PRODUCTS ARE NOT AUTHORIZED FOR USE AS CRITICAL COMPONENTS IN LIFE SUPPORT DEVICES OR SYSTEMS WITHOUT THE EXPRESS WRITTEN APPROVAL OF FAIRCHILD SEMICONDUCTOR CORPORATION.

As used herein:

- Life support devices or systems are devices or systems which, (a) are intended for surgical implant into the body, or (b) support or sustain life, or (c) whose failure to perform when properly used in accordance with instructions for use provided in the labeling, can be reasonably expected to result in significant injury to the user.
- A critical component is any component of a life support device or system whose failure to perform can be reasonably expected to cause the failure of the life support device or system, or to affect its safety or effectiveness.

PRODUCT STATUS DEFINITIONS

Definition of Terms

Datasheet Identification	Product Status	Definition
Advance Information	Formative or In Design	This datasheet contains the design specifications for product development. Specifications may change in any manner without notice.
Preliminary	First Production	This datasheet contains preliminary data, and supplementary data will be published at a later date. Fairchild Semiconductor reserves the right to make changes at any time without notice in order to improve design.
No Identification Needed	Full Production	This datasheet contains final specifications. Fairchild Semiconductor reserves the right to make changes at any time without notice in order to improve design.
Obsolete	Not In Production	This datasheet contains specifications on a product that has been discontinued by Fairchild semiconductor. The datasheet is printed for reference information only.